



 **WING**



WING

Designed by:
SHANNON SADLER

Wing è la nuova proposta di sedia per l'ambiente Contract: confortevole, versatile e di grande impatto estetico. Una monoscocca che avvolge completamente e invita a mettersi comodi.

ENG
Wing is the new chair proposal for the Contract environment: comfortable, versatile with a great aesthetic impact. A single-piece completely enveloping shell, inviting you to sit and get comfortable.

ESP
Wing es la nueva propuesta de silla para el ambiente Contract: confortable, versátil y con un gran impacto estético. Una monocarcasa totalmente envolvente para sentirse cómodos.

FRA
Wing est la nouvelle proposition de chaises pour les environnements contract: elle est confortable, polyvalente et de grand impact esthétique. Une monocoque totalement enveloppante qui donne envie de s'asseoir confortablement.

REGISTERED DESIGN



Nella versione a 4 gambe è impilabile fino ad 8 sedie. **Wing**, la scelta bella e funzionale!

ENG
The 4-leg version can stack up to 8 chairs. **Wing**, the beautiful and functional choice!

ESP
En la versión de 4 patas, se puede apilar un máximo de 8 sillas. **Wing**, una elección bonita y funcional!

FRA
Dans sa versions à 4 pieds, il est possible d'empiler jusqu'à 8 chaises. **Wing**, un beau choix fonctionnel!



Wing: 4 legs frame

Wing: wire frame

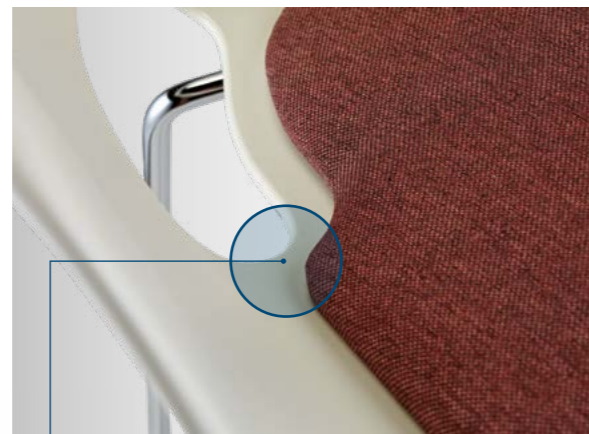

ENG

Several optional accessories are available, such as the coordinated plastic under-shell to maximize the design; or the seat panel to be upholstered to increase sitting comfort.

ESP

Varios accesorios opcionales, tales como, la parte inferior de la carcasa en plástico de color coordinado, para sacarle el máximo partido al diseño; o el panel tapizable para aumentar el confort del asiento.

FRA

Les accessoires en option sont nombreux, tels que la sous-coque en plastique dans une couleur coordonnée pour en accentuer le design ; ou le petit panneau à tapisser afin d'augmenter le confort d'assise.

Diversi gli accessori opzionabili, come il sottoscocca di plastica in colore coordinato, per massimizzarne il design; o il pannellino da tappezzare per aumentarne il comfort di seduta.



Wing: cantilever frame

Wing • Wing, the beautiful and functional choice!



Wing: 4 legs wood



Esteticamente sinuosa,
Wing arreda con gusto l'ambiente,
grazie anche alla caratteristica
linea decorativa dello schienale.

ENG
Aesthetically sinuous,
Wing tastefully furnishes
the environment, thanks
also to the characteristic
decorative line of the
backrest.

ESP
Wing, estéticamente
sinuosa, decora con gusto
el ambiente, también con
su característica línea
decorativa del respaldo.

FRA
Avec sa forme esthétique
arrondie, Wing aménage
avec goût un lieu grâce à
sa ligne de décoration du
dossier.

6.



7.



Wing: swivel

albacomponents



Wing: bench

8.



Optional available: E-USB



Shell colours



9.

Wing: 4 legs frame

01 •	SCOCOA A POZZETTO CON BRACCIOLI (ANTI-UV) PLASTIC SHELL WITH ARMS (ANTI-UV)	FINISHING	KIT	PACK	WT.x1	UNIT VOL.
133903-040	● NERO R9005/ BLACK R9005	x1	5	2,9	0,041	
133905-042	● AVORIO R1010 / IVORY R1010	x1	5	2,9	0,041	
133915-042	● BLU 541U / BLUE 541U	x1	5	2,9	0,041	
133902-042	● CORALLO 1797U / CORAL 1797U	x1	5	2,9	0,041	
133907-042	● FANGO 2312U / MUD 2312U	x1	5	2,9	0,041	

02 •	COPERTINA IN PLASTICA (ANTI-UV) PLASTIC COVER (ANTI-UV)	FINISHING	KIT	PACK	WT.x1	UNIT VOL.
132203-039	● NERO R9005/ BLACK R9005	x1	---	---	0,15	---
132205-039	● AVORIO R1010 / IVORY R1010	x1	---	---	0,15	---
132215-039	● BLU 541U / BLUE 541U	x1	---	---	0,15	---
132202-039	● CORALLO 1797U / CORAL 1797U	x1	---	---	0,15	---
132207-039	● FANGO 2312U / MUD 2312U	x1	---	---	0,15	---

03 •	VITE TSP+ M6x25 ZINCATA BIANCA (VITE PER FISSAGGIO SCOCOA CON COPERTINA) x 4G SL CV PC GIR SCREW TSP+ WHITE ZINC (SCREW FOR FIX SHELL WITH COVER)	FINISHING	KIT
117711-199	● ZINCATA/ZINC	x4	

04 •	PANNELLO SEDILE MULTISTRATO CON 6 BORCHIE M4 SEAT PANEL WITH 6 UPHOLSTERY NAIL M4	FINISHING	KIT	PACK	WT.x1	UNIT VOL.
122207-023	● FAGGIO/PLYWOOD	x1	20	0,3	0,0019	

05 •	VITE TBCL M4x10 ZINCATA BIANCA... (VITE PER FISSAGGIO PANNELLO SEDILE) SCREW TBCL M4x10 WITH THE ZINC (SCREW FOR FIX SEAT PANEL)	FINISHING	KIT
117703-124	● ZINCATA/ZINC	x6	

06 •	TELAIO 4 GAMBE D.16 SENZA TAPPI 4 LEGS FRAMES D.16 WITHOUT CAPS	FINISHING	PACK	WT.x1	UNIT VOL.
110603-613	● NERO/BLACK	150	2,05	0,014	
110605-613	● AVORIO R1013 / IVORY R1013	150	2,05	0,014	
110604-613	● GRIGIO/ GREY	150	2,05	0,014	
110607-613	● RAMATO/COPPER	150	2,05	0,014	
110610-613	● CROMATO / CHROME	150	2,05	0,014	
110603-614	● NERO/BLACK (per esterni / outdoor)	150	2,05	0,014	
110605-614	● AVORIO R1013 / IVORY R1013 (per esterni / outdoor)	150	2,05	0,014	
110604-614	● GRIGIO/ GREY (per esterni / outdoor)	150	2,05	0,014	

07 •	PUNTALE ALETTATO TONDO D.16 NERO INNER CAP FOR LEGS D.16 BLACK	FINISHING	KIT
134203-160	● NERO/BLACK	x4	

08 •	VITE TBL combi M6x12 DENTELL. ZINCATA BIANCA (VITE PER FISSAGGIO SCOCOA SENZA COPERTINA) 4G SL CV PC GIR SCREW TBL COMBI M6x12 WHITE ZINC (SCREW FOR FIX SHELL WITHOUT COVER)	FINISHING	KIT
117711-206	● ZINCATA/ZINC	x4	

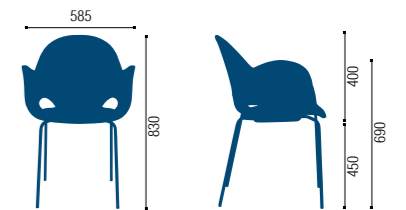

Wing: wire frame

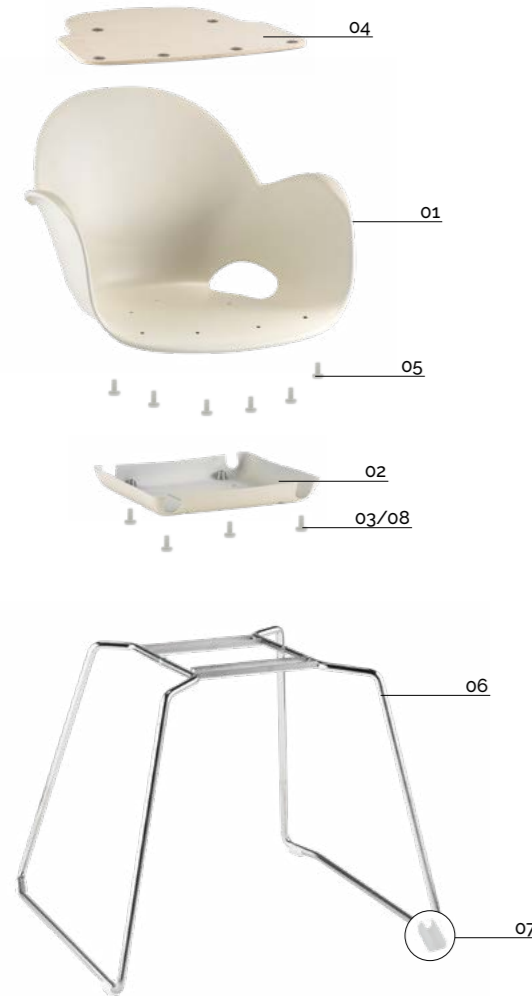

01 • **SCocca A POZZETTO CON BRACCIOLI (ANTI-UV)**
PLASTIC SHELL WITH ARMS (ANTI-UV)

CODE	FINISHING	KIT	PACK	WT.x1	UNIT VOL.
133903-040	● NERO R9005/ BLACK R9005	x1	5	2,9	0,041
133905-042	● AVORIO R1010 / IVORY R1010	x1	5	2,9	0,041
133915-042	● BLU 541U / BLUE 541U	x1	5	2,9	0,041
133902-042	● CORALLO 1797U / CORAL 1797U	x1	5	2,9	0,041
133907-042	● FANGO 2312U / MUD 2312U	x1	5	2,9	0,041

02 • **COPERTINA IN PLASTICA (ANTI-UV)**
PLASTIC COVER (ANTI-UV)

CODE	FINISHING	KIT	PACK	WT.x1	UNIT VOL.
132203-039	● NERO R9005/ BLACK R9005	x1	---	0,15	---
132205-039	● AVORIO R1010 / IVORY R1010	x1	---	0,15	---
132215-039	● BLU 541U / BLUE 541U	x1	---	0,15	---
132202-039	● CORALLO 1797U / CORAL 1797U	x1	---	0,15	---
132207-039	● FANGO 2312U / MUD 2312U	x1	---	0,15	---

03 • **VITE TSP+ M6x25 ZINCATA BIANCA**
(VITE PER FISSAGGIO SCocca CON COPERTINA) x 4G SL CV PC GIR
SCREW TSP+ WHITE ZINC (SCREW FOR FIX SHELL WITH COVER)

CODE	FINISHING	KIT
117711-199	● ZINCATA/ZINC	x4

04 • **PANNELLO SEDILE MULTISTRATO CON 6 BORCHIE M4**
SEAT PANEL WITH 6 UPHOLSTERY NAIL M4

CODE	FINISHING	KIT	PACK	WT.x1	UNIT VOL.
122207-023	● FAGGIO/PLYWOOD	x1	20	0,3	0,0019

Shell colours



05 • **VITE TBCL M4x10 ZINCATA BIANCA... (VITE PER FISSAGGIO PANNELLO SEDILE)**
SCREW TBCL M4x10 WITH THE ZINC (SCREW FOR FIX SEAT PANEL)

CODE	FINISHING	KIT
117703-124	● ZINCATA/ZINC	x6

06 • **TELAIO A SLITTA IN TONDINO D.12**
SLIDE WIRE FRAME D.12

CODE	FINISHING	KIT	PACK	WT.x1	UNIT VOL.
113407-400	● RAMATO/COPPER	x1	100	3,54	0,026
113410-400	● CROMATO / CHROME	x1	100	3,54	0,026

07 • **CONFEZIONE DI BASI A PINZA ANTIROTAZIONE PER TONDINO COLORE NEUTRO**
NEUTRAL CLIPS BASE FOR WIRE D.11 PACKAGE

CODE	FINISHING	KIT	PACK
137006-070	● NEUTRO/NEUTRAL	x4	200

08 • **VITE TBL combi M6x12 DENTELL. ZINCATA BIANCA**
(VITE PER FISSAGGIO SCocca SENZA COPERTINA) 4G SL CV PC GIR
SCREW TBL COMBI M6x12 WHIE ZINC (SCREW FOR FIX SHELL WITHOUT COVER)

CODE	FINISHING	KIT
117711-206	● ZINCATA/ZINC	x4

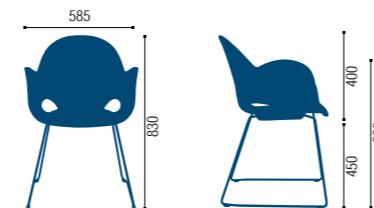

Shell colours



Wing: 4 legs wood



01 • **SCocca A POZZETTO CON BRACCIOLI (ANTI-UV)**
PLASTIC SHELL WITH ARMS (ANTI-UV)

CODE	FINISHING	KIT	PACK	WT.x1	UNIT VOL.
133903-040	● NERO R9005/ BLACK R9005	x1	5	2,9	0,041
133905-042	● AVORIO R1010 / IVORY R1010	x1	5	2,9	0,041
133915-042	● BLU 541U / BLUE 541U	x1	5	2,9	0,041
133902-042	● CORALLO 1797U / CORAL 1797U	x1	5	2,9	0,041
133907-042	● FANGO 2312U / MUD 2312U	x1	5	2,9	0,041

02 • **PANNELLO SEDILE MULTISTRATO CON 6 BORCHIE M4**
SEAT PANEL WITH 6 UPHOLSTERY NAIL M4

CODE	FINISHING	KIT	PACK	WT.x1	UNIT VOL.
122207-023	● FAGGIO/PLYWOOD	x1	20	0,3	0,0019

03 • **VITE TBCL M4x10 ZINCATA BIANCA... (VITE PER FISSAGGIO PANNELLO SEDILE)**
SCREW TBCL M4x10 WITH THE ZINC (SCREW FOR FIX SEAT PANEL)

CODE	FINISHING	KIT
117703-124	● ZINCATA/ZINC	x6

04 • **KIT 4 GAMBE LEGNO MASSELLO FAGGIO TRASPARENTE + PIASTRA IN METALLO**
KIT BEECH 4 LEGS FRAMES WITH METAL PLATE

CODE	FINISHING	KIT	PACK	WT.x1	UNIT VOL.
120107-000	● FAGGIO/BEECH	x1	---	---	---

05 • **VITE TBL combi M6x16 dentell. zinc. bianco**
(VITE PER FISSAGGIO SCocca SENZA COPERTINA) LEGNO
SCREW TBL COMBI WHITE ZINC (SCREW FOR FIX SHELL WITHOUT COVER)

CODE	FINISHING	KIT
117711-191	● ZINCATA/ZINC	x4

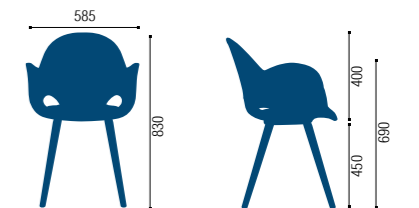

Wing: cantilever



01 • **SCOCOA A POZZETTO CON BRACCIOLI (ANTI-UV)**
PLASTIC SHELL WITH ARMS (ANTI-UV)

CODE	FINISHING	KIT	PACK	WT.x1	UNIT VOL.
133903-040	● NERO R9005/ BLACK R9005	x1	5	2,9	0,041
133905-042	● AVORIO R1010 / IVORY R1010	x1	5	2,9	0,041
133915-042	● BLU 541U / BLUE 541U	x1	5	2,9	0,041
133902-042	● CORALLO 1797U / CORAL 1797U	x1	5	2,9	0,041
133907-042	● FANGO 2312U / MUD 2312U	x1	5	2,9	0,041

02 • **COPERTINA IN PLASTICA (ANTI-UV)**
PLASTIC COVER (ANTI-UV)

CODE	FINISHING	KIT	PACK	WT.x1	UNIT VOL.
132203-039	● NERO R9005/ BLACK R9005	x1	---	0,15	---
132205-039	● AVORIO R1010 / IVORY R1010	x1	---	0,15	---
132215-039	● BLU 541U / BLUE 541U	x1	---	0,15	---
132202-039	● CORALLO 1797U / CORAL 1797U	x1	---	0,15	---
132207-039	● FANGO 2312U / MUD 2312U	x1	---	0,15	---

03 • **VITE TSP+ M6x25 ZINCATA BIANCA**
(VITE PER FISSAGGIO SCOCOA CON COPERTINA) x 4G SL CV PC GIR
SCREW TSP+ WHITE ZINC (SCREW FOR FIX SHELL WITH COVER)

CODE	FINISHING	KIT
117711-199	● ZINCATA/ZINC	x4

04 • **PANNELLO SEDILE MULTISTRATO CON 6 BORCHIE M4**
SEAT PANEL WITH 6 UPHOLSTERY NAIL M4

CODE	FINISHING	KIT	PACK	WT.x1	UNIT VOL.
122207-023	● FAGGIO/PLYWOOD	x1	20	0,3	0,0019

05 • **VITE TBCL M4x10 ZINCATA BIANCA...** (VITE PER FISSAGGIO PANNELLO SEDILE)
SCREW TBCL M4x10 WITH ZINC (SCREW FOR FIX SEAT PANEL)

CODE	FINISHING	KIT
117703-124	● ZINCATA/ZINC	x6

06 • **CANTILEVER FRAMES D.22 WITHOUT CAPS**
CANTILEVER FRAMES D.22 WITHOUT CAPS

CODE	FINISHING	KIT	PACK	WT.x1	UNITVOL.
110503-480	● NERO/BLACK	x1	64	3,77	0,0313
110505-480	● AVORIO R1013 / IVORY R1013	x1	64	3,77	0,0313
110504-480	● GRIGIO/ GREY	x1	64	3,77	0,0313
110510-480	● CROMATO / CHROME	x1	64	3,77	0,0313

07 • **PINZA DUE PIOLI IN POLIETILENE NERA**
TWO PINS PLIERS IN BLACK POLYTHENE

CODE	FINISHING	KIT	PACK	WT.x1	UNITVOL.
134003-003	● NERO/BLACK	x6	---	0,05	---

08 • **TAPPO COPRITESTA ø22 PER CANTILEVER**
COVER HEAD CAP ø22 FOR CANTILEVER

CODE	FINISHING	KIT
134103-220	● NERO/BLACK	x2
134104-220	● GRIGIO/ GREY	x2

09 • **VITE TBL combi M6x12 DENTELL. ZINCATA BIANCA**
(VITE PER FISSAGGIO SCOCOA SENZA COPERTINA) 4G SL CV PC GIR
SCREW TBL COMBI M6x12 WHIE ZINC (SCREW FOR FIX SHELL WITHOUT COVER)

CODE	FINISHING	KIT
117711-206	● ZINCATA/ZINC	x4

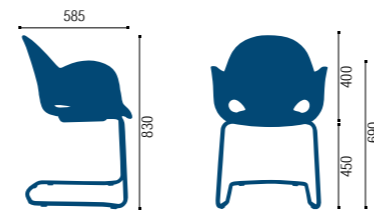

Shell colours



Wing: swivel



01 • **SCOCOA A POZZETTO CON BRACCIOLI (ANTI-UV)**
PLASTIC SHELL WITH ARMS (ANTI-UV)

CODE	FINISHING	KIT	PACK	WT.x1	UNIT VOL.
133903-040	● NERO R9005/ BLACK R9005	x1	5	2,9	0,041
133905-042	● AVORIO R1010 / IVORY R1010	x1	5	2,9	0,041
133915-042	● BLU 541U / BLUE 541U	x1	5	2,9	0,041
133902-042	● CORALLO 1797U / CORAL 1797U	x1	5	2,9	0,041
133907-042	● FANGO 2312U / MUD 2312U	x1	5	2,9	0,041

02 • **VITE TBL combi M6x12 DENTELL. ZINCATA BIANCA**
(VITE PER FISSAGGIO SCOCOA SENZA COPERTINA) 4G SL CV PC GIR
SCREW TBL COMBI M6x12 WHIE ZINC (SCREW FOR FIX SHELL WITHOUT COVER)

CODE	FINISHING	KIT
117711-206	● ZINCATA/ZINC	x4

03 • **PANNELLO SEDILE MULTISTRATO CON 6 BORCHIE M4**
SEAT PANEL WITH 6 UPHOLSTERY NAIL M4

CODE	FINISHING	KIT	PACK	WT.x1	UNIT VOL.
122207-023	● FAGGIO/PLYWOOD	x1	20	0,3	0,0019

04 • **VITE TBCL M4x10 ZINCATA BIANCA...** (VITE PER FISSAGGIO PANNELLO SEDILE)
SCREW TBCL M4x10 WITH ZINC (SCREW FOR FIX SEAT PANEL)

CODE	FINISHING	KIT
117703-124	● ZINCATA/ZINC	x6

05 • **BASE 4 RAZZE D720 IN ALLUMINIO**
HIGH ALUMINIUM BASE D.720

CODE	FINISHING	KIT	PACK	WT.x1	UNITVOL.
110210-090	● ALLUMINIO/ALUMINIUM	x1	6	4,03	---

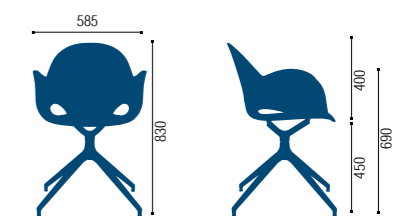

Shell colours



Wing: swivel

01 • **SCOCCA A POZZETTO CON BRACCIOLI (ANTI-UV)**
PLASTIC SHELL WITH ARMS (ANTI-UV)

CODE	FINISHING	KIT	PACK	WT.x1	UNIT VOL.
133903-040	● NERO R9005/ BLACK R9005	x1	5	2,9	0,041
133905-042	● AVORIO R1010 / IVORY R1010	x1	5	2,9	0,041
133915-042	● BLU 541U / BLUE 541U	x1	5	2,9	0,041
133902-042	● CORALLO 1797U / CORAL 1797U	x1	5	2,9	0,041
133907-042	● FANGO 2312U / MUD 2312U	x1	5	2,9	0,041

02 • **COPERTINA IN PLASTICA (ANTI-UV)**
PLASTIC COVER (ANTI-UV)

CODE	FINISHING	KIT	PACK	WT.x1	UNIT VOL.
132203-039	● NERO R9005/ BLACK R9005	x1	---	0,15	---
132205-039	● AVORIO R1010 / IVORY R1010	x1	---	0,15	---
132215-039	● BLU 541U / BLUE 541U	x1	---	0,15	---
132202-039	● CORALLO 1797U / CORAL 1797U	x1	---	0,15	---
132207-039	● FANGO 2312U / MUD 2312U	x1	---	0,15	---

03 • **VITE TSP+ M6x25 ZINCATA BIANCA**
(VITE PER FISSAGGIO SCOCCA CON COPERTINA) x 4G SL CV PC GIR
SCREW TSP+ WHITE ZINC (SCREW FOR FIX SHELL WITH COVER)

CODE	FINISHING	KIT
117711-199	● ZINCATA/ZINC	x4

04 • **PANNELLO SEDILE MULTISTRATO CON 6 BORCHIE M4**
SEAT PANEL WITH 6 UPHOLSTERY NAIL M4

CODE	FINISHING	KIT	PACK	WT.x1	UNIT VOL.
122207-023	● FAGGIO/PLYWOOD	x1	20	0,3	0,0019

05 • **VITE TBCL M4x10 ZINCATA BIANCA...** (VITE PER FISSAGGIO PANNELLO SEDILE)
SCREW TBCL M4x10 WITH ZINC (SCREW FOR FIX SEAT PANEL)

CODE	FINISHING	KIT
117703-124	● ZINCATA/ZINC	x6

06 • **PIASTRA PER PANCA/GIREVOLE VERNICIATA**
PLATE FOR BENCH/SWIVEL PAINT

CODE	FINISHING	KIT	PACK	WT.x1	UNIT VOL.
110703-013	● NERO/BLACK	x1	25	0,85	0,0008
110704-078	● GRIGIO/ GREY	x1	25	0,85	0,0008

07 • **BLOCCHETTO IN ALLUMINIO 0° D.28 x GAS CON LEVA NERO OPACO**
BLACK ALU BLOCK 0° D.28 x GAS WITH LEVAR

CODE	FINISHING	KIT	PACK	WT.x1	UNIT VOL.
110903-101	● NERO/BLACK	x1	25	0,305	0,0225

08 • **BASE IN METALLO D.640 CON COPRISALDATURA**
METAL BASE D.640 WITH COVER WELDING

CODE	FINISHING	KIT	PACK	WT.x1	UNIT VOL.
110210-057	● CROMATO / CHROME	x1	5	2,25	0,0117
110210-058	● CROMATO / CHROME	x1	5	2,5	0,0126

09 • **VITE TBL combi M6x12 DENTELL. ZINCATA BIANCA**
(VITE PER FISSAGGIO SCOCCA SENZA COPERTINA) 4G SL CV PC GIR
SCREW TBL COMBI M6x12 WHITE ZINC (SCREW FOR FIX SHELL WITHOUT COVER)

CODE	FINISHING	KIT
117711-206	● ZINCATA/ZINC	x4

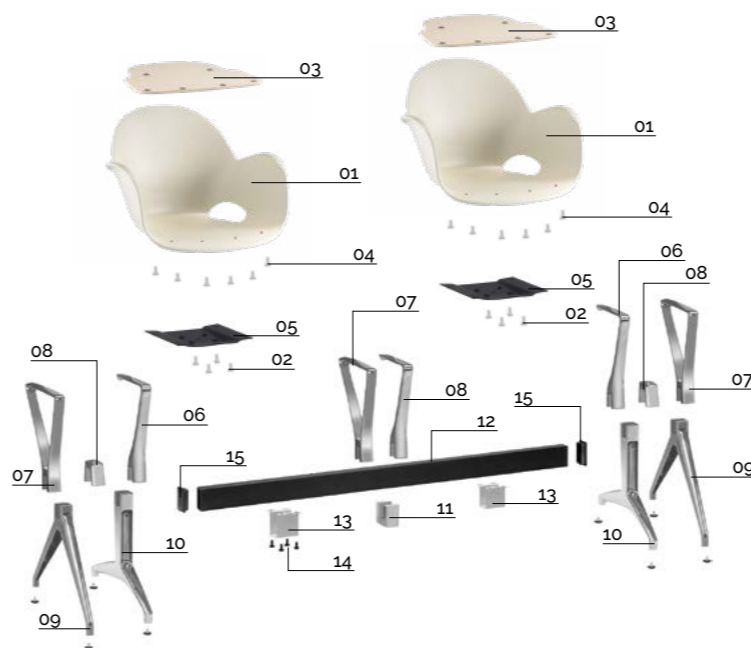
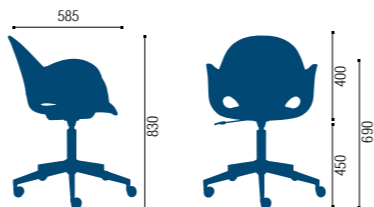

leg and armrest solutions



table solutions



Wing: bench

01 • **SCOCCA A POZZETTO CON BRACCIOLI (ANTI-UV)**
PLASTIC SHELL WITH ARMS (ANTI-UV)

CODE	FINISHING	KIT	PACK	WT.x1	UNIT VOL.
133903-040	● NERO R9005/ BLACK R9005	x1	5	2,9	0,041
133905-042	● AVORIO R1010 / IVORY R1010	x1	5	2,9	0,041
133915-042	● BLU 541U / BLUE 541U	x1	5	2,9	0,041
133902-042	● CORALLO 1797U / CORAL 1797U	x1	5	2,9	0,041
133907-042	● FANGO 2312U / MUD 2312U	x1	5	2,9	0,041

02 • **VITE TBL combi M6x12 DENTELL. ZINCATA BIANCA**
(VITE PER FISSAGGIO SCOCCA SENZA COPERTINA) 4G SL CV PC GIR
SCREW TBL COMBI M6x12 WHITE ZINC (SCREW FOR FIX SHELL WITHOUT COVER)

CODE	FINISHING	KIT
117711-206	● ZINCATA/ZINC	x4

03 • **PANNELLO SEDILE MULTISTRATO CON 6 BORCHIE M4**
SEAT PANEL WITH 6 UPHOLSTERY NAIL M4

CODE	FINISHING	KIT	PACK	WT.x1	UNIT VOL.
122207-023	● FAGGIO/PLYWOOD	x1	20	0,3	0,0019

04 • **VITE TBCL M4x10 ZINCATA BIANCA...** (VITE PER FISSAGGIO PANNELLO SEDILE)
SCREW TBCL M4x10 WITH ZINC (SCREW FOR FIX SEAT PANEL)

CODE	FINISHING	KIT
117703-124	● ZINCATA/ZINC	x6

05 • **PIASTRA PER PANCA/GIREVOLE VERNICIATA**
PLATE FOR BENCH/SWIVEL PAINT

CODE	FINISHING	KIT	PACK	WT.x1	UNIT VOL.
110703-013	● NERO/BLACK	x1	25	0,85	0,0008
110704-078	● GRIGIO/ GREY	x1	25	0,85	0,0008

06 • **NEXUS-CUT-BRACCIOLO IN ALLUMINIO PER PANCA + N°2 VITI**
NEXUS-CUT-ALUMINIUM ARM FOR BENCH + N°2 SCREW

CODE	FINISHING	KIT	PACK	WT.x1	UNIT VOL.
111704-223	● ALLUMINIO/ALUMINIUM	x1	10	1,40	mc. 00011

07 • **NEXUS-SLIM-BRACCIOLO IN ALLUMINIO PER PANCA + N°2 VITI**
NEXUS-SLIM-ALUMINIUM ARM FOR BENCH + N°2 SCREW

CODE	FINISHING	KIT	PACK	WT.x1	UNIT VOL.
111704-225	● ALLUMINIO/ALUMINIUM	x1	10	1,40	mc. 00011

08 • **NEXUS-CUT/SLIM-CAVALLOTTO IN ALLUM. PER GAMBA PANCA + N°2 VITI**
NEXUS-CUT/SLIM-ALUM.BRACKET 80x40 FOR BENCH LEG + N°2 SCREW

CODE	FINISHING	KIT	PACK	WT.x1	UNIT VOL.
111704-222	● ALLUMINIO/ALUMINIUM	x1	10	0,40	mc. 00012

09 • **NEXUS-SLIM-GAMBA IN ALLUMINIO PER PANCA**
NEXUS-SLIM-ALUMINIUM LEG FOR BENCH

CODE	FINISHING	KIT	PACK	WT.x1	UNIT VOL.
111704-226	● ALLUMINIO/ALUMINIUM	x2	5	1,20	mc. 0,014

10 • **NEXUS-CUT-GAMBA IN ALLUMINIO PER PANCA**
NEXUS-CUT-ALUMINIUM LEG FOR BENCH

CODE	FINISHING	KIT	PACK	WT.x1	UNIT VOL.
111704-224	● ALLUMINIO/ALUMINIUM	x2	5	2,55	mc. 0,014

11 • **NEXUS-CUT/SLIM-CAVALLOTTO IN ALLUMINIO PER BRACCIOLO PANCA**
NEXUS-CUT/SLIM-ALUMINIUM BRACKET 80x40 FOR BENCH ARM

CODE	FINISHING	KIT	PACK	WT.x1	UNIT VOL.
111704-221	● ALLUMINIO/ALUMINIUM	x1	10	0,32	mc. 0,0012

12 • **90T(03) BEAM FOR BENCH 80X40**
90T(03) BEAM FOR BENCH 80X40

CODE	FINISHING	NOTE	KIT	PACK	WT.x1	UNIT VOL.	LENGHT
110703-190	● NERO/BLACK	2 POSTI/2 SEATS	x1	1	3,20	mc. 0,0045	1160
110704-190	● GRIGIO/ GREY	2 POSTI/2 SEATS	x1	1	3,20	mc. 0,0045	1160
110703-191	● NERO/BLACK	3 POSTI/3 SEATS	x1	1	4,71	mc. 0,005	1710
110704-191	● GRIGIO/ GREY	3 POSTI/3 SEATS	x1	1	4,71	mc. 0,005	1710
110703-192	● NERO/BLACK	4 POSTI/4 SEATS	x1	1	6,22	mc. 0,0085	2260
110704-192	● GRIGIO/ GREY	4 POSTI/4 SEATS	x1	1	6,22	mc. 0,0085	2260
110703-193	● NERO/BLACK	5 POSTI/5 SEATS	x1	1	7,72	mc. 0,01	2800
110704-193	● GRIGIO/ GREY	5 POSTI/5 SEATS	x1	1	7,72	mc. 0,01	2800

13 • **90CV-CAVALLOTTO SOTTOTRAVE**
90CV-SUPPORT UNDER BEAM

CODE	FINISHING	KIT	PACK	WT.x1	UNIT VOL.
110703-007	● NERO/BLACK	x1	50	0,60	mc. 0,0005
110704-016	● GRIGIO/ GREY	x1	50	0,60	mc. 0,0005

14 • **CONFEZIONE VITI M8x12 TESTA CILINDRICA A ESAGONO INCASSATO BRUNITA NERA**
SCREWS M8x12 CYLINDRICAL HEAD HEXAGON EMBEDDED BURNISHING BLACK PACKAGE

CODE	FINISHING	KIT	PACK
117003-070	● NERO/BLACK	x4	200

15 • **TAPPO COPRITESTA RETTANGOLARE 80x40 NERO**
RECTANGULAR COVER HEAD CAP 80x40 BLACK

CODE	FINISHING	KIT	PACK
134103-001	● NERO/BLACK	x2	---

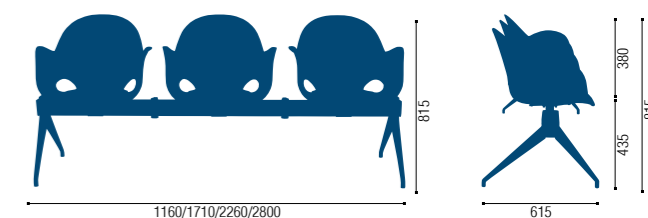

alba components

ITALIAN CHAIR SOLUTION

Via Boschier, 54/A Località Ca' Rainati
31020 San Zenone degli Ezzelini (TV) - ITALY

t +39 0423 969700 r.a.
f +39 0423 964014

www.metalmeccanicaalba.com
info@metalmeccanicaalba.it

METALMECCANICA ALBA srl  TWINSNE
TWORK